

# City of Foster City

## ESTERO MUNICIPAL IMPROVEMENT DISTRICT

610 FOSTER CITY BOULEVARD  
FOSTER CITY, CA 94404-2222  
(650) 286-3200  
FAX (650) 574-3483

### CITY OF FOSTER CITY COMMUNITY DEVELOPMENT DIRECTOR'S ACTION NOTICE OF DECISION

APPLICATION RECEIVED: February 26, 2010

APPLICATION COMPLETE: January 25, 2011

ACTION DATE: February 9, 2011

CASE NO: UP-85-0230

OWNER: Alden Park Homeowners' Association

ADDRESS: c/o Ron Khan, Alden Park Board of Directors, 816 Prowshead Lane,  
Foster City, CA 94404

APPLICATION FOR: Various prototype designs for improvements: Fences, Garage Doors,  
House Colors, Roofs, Skylights, Windows, Garden Structures,  
Decks, Trellises, Gazebos, Greenhouses, Lighting, Pools and Spas

LOCATION: Alden Park

ZONING: R-1/PD

ACTION TAKEN: Approved with Conditions

On the date listed above, the Community Development Director of the City of Foster City, took the action described above on the subject Architectural Review application based on the following findings:

1. The proposal to establish prototype designs for various property improvements, as conditioned in Exhibit A, would be consistent with the Foster City General Plan, Chapter 17.12 (R-1 Single-Family Residence District) of Title 17 (Zoning), and Chapter 2.28 (Planning) of Title 2 (Administration and Personnel) of the Foster City Municipal Code, because the prototype designs: 1) will be sympathetic to the character and style of the existing development and will be designed to be harmonious with the existing neighborhood and therefore, will promote "proper site planning, architectural design and property maintenance" and will preserve "the quality of the City's residential neighborhoods" as stated in the Land Use and Circulation Goals (LUC-A and LUC-B) and Land Use Policies (LUC-38 and LUC-39) contained in the Land Use and Circulation Element of the Foster City General Plan; 2) will be integrated into the existing building and designed such that the architectural character of the Alden Park Planned Development is maintained and such that solar and privacy impacts will not be created on adjacent properties, consistent with Section 2.28.010 of the Foster City Municipal Code; and 3) will improve a typical residential use consistent with the Land Use Plan designation of Single-Family Residential and the Alden Park Planned Development.
2. That the design of the proposal would be consistent with and appropriate to the City, the neighborhood, and the lot on which they are proposed because the locations, sizes, and designs

of the improvements outlined in the Alden Park Prototypical Design Guidelines will be compatible with the location, size, and design of the houses in the Alden Park Planned Development.

3. That the design of the proposal would be compatible with the site's environment with respect to use, forms, materials, colors, setbacks, location, height, design or similar qualities as specified in Section 17.58.010 of Chapter 17.58 (Architectural Control and Supervision) because the prototype designs: 1) will be compatible with the existing houses and planned development, and therefore, will preserve the architectural scale and character of the planned development and community consistent with Section 17.58.010.B.1; 2) will be well designed in relation to surrounding properties, and therefore, will be compatible with the architectural style and details of buildings in the immediate vicinity consistent with Section 17.58.010.B.2; and 3) will be sympathetic to the proportions and character of the existing house and neighborhood, and therefore, will enhance their site and will be harmonious with the highest standards of improvement in the surrounding area consistent with Section 17.58.010.B.4.
4. That the proposal would not, under the circumstances of the particular case, be detrimental to the health, safety, morals, comfort and general welfare of the persons residing or working in the neighborhood of such proposed use, and will not be injurious or detrimental to property and improvements in the neighborhood, property values in the area, or the general welfare of the City because the location, massing, and design of the prototype designs will not: 1) significantly impact the privacy of adjacent properties; 2) significantly reduce the amount of direct sunlight to the interior of an adjacent building or exterior of an adjacent property; or 3) significantly block or limit existing views from the interior or exterior of adjacent properties, consistent with Section 17.58.010.B.3 of the Foster City Municipal Code.

This action is subject to any conditions contained in Exhibit A, attached.

#### Expiration

Any Architectural Review approval shall, without further action, become null and void if not used within two (2) years from the date of approval thereof, or within any shorter or longer period of time if so approved by the Community Development Director.

#### Appeal

Pursuant to Section 17.06.150 of the Foster City Municipal Code, an action of the Community Development Director on an application may be appealed within ten (10) calendar days after the date of the Community Development Director's decision, in writing, to the Planning Commission. Appeals may be filed using the appeal form available in the Community Development Department or by letter. There is a fee for filing an appeal. All appeals must be filed in accordance with Section 17.06.150.

#### Acknowledgment by Applicant

Pursuant to Section 17.58.040.E of the Foster City Municipal Code, any Architectural Review decision shall not be effective until the permittee acknowledges acceptance of any conditions of approval and any appeal period has lapsed, or if there is an appeal, until a final decision has been made on the appeal.

In order to demonstrate that you are aware of and understand the Architectural Review conditions of approval (attached hereto as Exhibit A), please sign the original of this letter and return it to the Planning/Code Enforcement Division. Please keep the duplicate for your records. *Please be advised that a Building Permit will not be issued until the Planning/Code Enforcement Division has received the signed Notice of Decision.*

Sincerely,

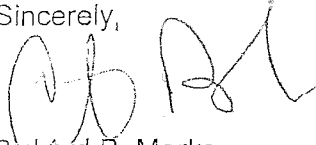

Sec Richard B. Marks  
Community Development Director

---

(Owner's Name) (Please Print)

Planners Initials: kak

---

(Owner's Signature)

## EXHIBIT A

### ALDEN PARK HOMEOWNERS' ASSOCIATION

Prototypical Design Guidelines for:  
Fences, Garage Doors, House Colors, Roofs, Skylights, Solar Collectors, Windows, Garden Structures, Decks, Trellises, Gazebos, Unattached Greenhouses, Lighting, Pools and Spas

The Amended Prototypical Design Guidelines for Alden Park, dated April 2010 shall govern the installation and replacement of the property improvements listed above in the Alden Park Planned Development, except as modified by the Conditions of Approval and Approval Process requirements listed below:

#### CONDITIONS OF APPROVAL

1. All construction shall be designed, constructed, installed, and maintained in a professional manner and appearance.
2. All materials and colors shall be as approved. Once constructed or installed, all improvements shall be maintained in accordance with the approved plans. Any changes which affect the exterior character of the work shall be resubmitted for approval. The construction or placement of unapproved features or unapproved changes to buildings or structures which were a part of approved plans can and will result in the issuance of a "Stop Work Order" by the City, the need to revise plans and obtain City approval for all changes prior to recommending work, and the possibility of penalty fees being assessed for unauthorized work.
3. Standard residential security requirements as established by Chapter 15.28 of the Foster City Municipal Code shall be provided.
4. Prior to any final building inspection approval, imposed conditions and all improvements shall be completed to the satisfaction of the City.
5. All architectural elements such as soffits, screens, etc. not shown or detailed on the plans shall be finished in a material and color in harmony with the exterior of the building.
6. This approval shall supercede all previous prototype approvals for the prototypical property improvements listed above, including UP-85-023K.
7. This approval shall eliminate the prototype for solar collectors.

## **APPROVAL PROCESS**

### **A. For Garage Doors & Roofs (BP only):**

1. The homeowner or contractor shall apply for a Building Permit from the Building Inspection Division and shall submit any required drawings and fees including the following:
  - i. For a garage door: four copies of drawings and/or brochures indicating the design of the proposed garage door.
  - ii. Building permit application and fee.
  - iii. For a roof: manufacturer's name, style and color of the proposed material.
2. The Planning/Code Enforcement Division staff will review the Building Permit application to confirm that the proposal is consistent with the prototypical design approved.

### **B. For Replacement Windows, Pools and Spas (BP only):**

1. The homeowner or contractor shall apply for a Building Permit from the Building Inspection Division and shall submit any required drawings and fees including the following:
  - i. Building Permit application and fee.
  - ii. Completed Window Schedule with Photos
  - iii. Four copies of a site plan and drawings and/or brochures indicating the design of the proposed improvement.
2. The Planning/Code Enforcement Division staff will review the Building Permit application to confirm that the proposal is consistent with the prototypical design approved.

### **C. For Fences (AR only):**

1. For fences along public streets; the homeowner or contractor shall apply for an Architectural Review Permit from the Planning/Code Enforcement Division and shall submit any required drawings and fees including the following:
  - i. An Architectural Review application and filing fee.
  - ii. Three copies of a site plan and drawings/photo indicating the location and design of the proposed fence.
2. The Planning/Code Enforcement Division staff will review the Architectural Review application to confirm that the proposal is consistent with the prototypical design approved.
3. For prototypical privacy fences that do not adjoin a public right of way, an architectural review permit and building permit are not required.

**D. For Arbors, Trellises, Gazebos, Unattached Greenhouses, Decks taller than 18" from grade or less than 5' from the property line, other Garden Structures taller than the fence, and New (not replacement) Windows (HOA & AR & BP):**

1. The homeowner or contractor shall apply for an Architectural Review from the Planning/Code Enforcement Division and shall submit any required drawings and fees including the following:
  - i. A letter from the Alden Park Homeowners Association (HOA), indicating their action on the proposal (when applicable).
  - ii. An Architectural Review application and filing fee.
  - iii. Three copies of a site plan and drawings/brochure indicating the location and design of the proposed structure.
2. Planning/Code Enforcement Division staff will review the Architectural Review application to confirm that the proposal is consistent with the prototypical design approved.
3. The homeowner or contractor shall apply for a Building Permit from the Building Inspection Division and shall submit any required drawings and fees including the following:
  - i. Four copies of a site plan and drawings and/or brochures indicating the location and design of the proposed improvement.
  - ii. Building Permit application and filing fee.
  - iii. The Planning/Code Enforcement Division staff will review the Building Permit application to confirm that the proposal is consistent with the prototypical design approved and the Architectural Review approval.

**E. For Skylights (HOA & BP)**

1. The homeowner or contractor shall apply for a Building Permit from the Building Inspection Division and shall submit any required drawings and fees including the following:
  - i. A letter from the Alden Park Homeowners Association (HOA), indicating their action on the proposal.
  - ii. Building Permit application and fee.
  - iii. Four copies of a site plan and drawings and/or brochures indicating the location, colors and materials of the proposed skylight(s).

**F. For Roofs (BP only)**

1. The homeowner or contractor shall apply for a Building Permit from the Building Inspection Division and shall submit any required drawings and fees including the following:
  - i. Building Permit application and fee including existing roofing material and proposed roofing material.
2. The Planning/Code Enforcement Division staff will review the Building Permit application to confirm that the proposal is consistent with the prototypical approved roof.

**G. For House Colors, Lighting, Decks less than 18" from grade, garden structures other than decks that are lower than the fence (no City review required):**

No permit or prior approval from the City of Foster City for the items listed above is required (however, prior approval from the Alden Park Homeowners' Association is required).

\_\_\_\_\_  
Name (Print)

Alden Park Homeowners' Association

\_\_\_\_\_  
Date

\_\_\_\_\_  
Richard B. Marks, Community Development Director  
City of Foster City

\_\_\_\_\_  
Date

## DWELLING IMPROVEMENTS

DWELLING IMPROVEMENTS are attached to the dwelling units and include sun and patio rooms, greenhouses, window improvements, skylights, and room additions. All such structures shall conform to these guidelines and to the Foster City building and zoning code.

### MATERIALS

New construction: Match the existing dwelling in color, material, texture, height, scale, trim and architectural style.

Shop-fabricated: Metal and wood to be painted to match dwelling color and trim.

Glass: Plexiglas and other transparent substitutes are not permitted except for skylights. Only clear glass is permitted.

### LOCATIONS

Sun/patio rooms, attached greenhouses and room additions are allowed in side and rear yards only within an area defined by projection of the house walls, and to within five (5) feet of the side property line and ten (10) feet of the rear property line.

Skylights shall not exceed the height of the roof ridge to which they are attached and are to be flush mounted.

Window improvements, such as "greenhouse windows," may be installed in sideyards, but shall not extend closer than 18 inches to side property line.

### NOTE:

All room additions as defined by the Uniform Building Code shall until further notice require Planning Commission approval.



FOSTER CITY  
RECEIVED  
OCT 29 2010  
PLANNING  
DIVISION

# PROTOTYPICAL DESIGN GUIDELINES

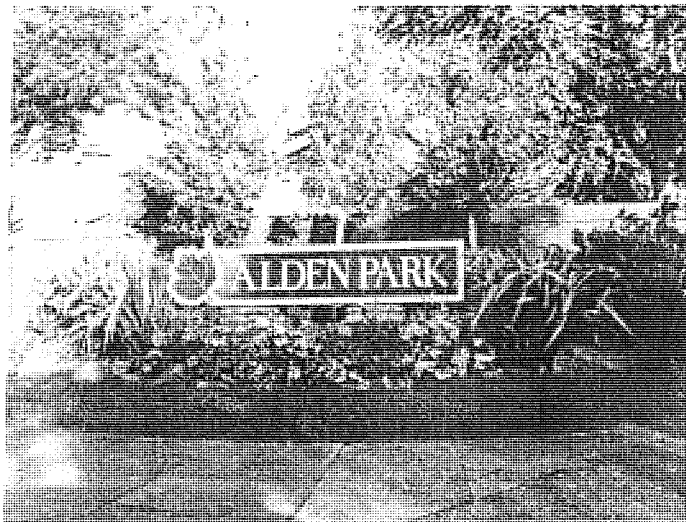

## ALDEN PARK

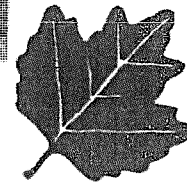

HOMEOWNERS' ASSOCIATION  
FOSTER CITY, CALIFORNIA

*Revised April 2010*

00-85-0230  
CITY OF FOSTER CITY  
PLANNING DEPARTMENT

FEB 10 2011

ADMINISTRATIVE APPROVAL  
WITH CONDITIONS



OCT 29 2010

PLANNING  
DIVISION

**TABLE OF CONTENTS**

CITY OF FOSTER CITY CONDITIONS OF APPROVAL .....	2
PROTOTYPICAL DESIGN GUIDELINES AND NEIGHBOR NOTIFICATIONS .....	2
ALDEN PARK CONDITIONS OF APPROVAL .....	3
Fences .....	3
Garage Doors .....	4
Prototypical Design for Garage Doors .....	5
House Colors .....	6
Exterior Paint Rules .....	7
Roofs .....	8
Skylights .....	8
Windows .....	9
Yard Features .....	10
Garden Structures .....	10
Trellises, Greenhouses & Gazebos .....	10
Locations & Setbacks .....	11
Decks, Patios, Flatworks, etc. ....	12
Lighting .....	12
Pools and Spas .....	12
Prototypical Trellis & Wood Deck .....	13
Prototypical Unattached Greenhouse & Gazebos .....	14
Yard Feature Approval Process .....	15
ALDEN PARK SITE MAP WITH ADDRESSES & LOT NUMBERS .....	16
ALDEN PARK COUNTY ASSESSOR'S MAP .....	17

OP-85-0230  
CITY OF FOSTER CITY  
PLANNING DEPARTMENT

FEB 10 2011

ADMINISTRATIVE APPROVAL  
WITH CONDITIONS



OCT 29 2010

CITY OF FOSTER CITY CONDITIONS OF APPROVAL

PLANNING  
DIVISION

1. Prior to commencement of work, a building permit shall be obtained if necessary from the Building Inspection Division of the City of Foster City.
2. All construction shall be designed, constructed, installed and maintained in a professional manner and appearance.
3. All materials and colors shall be as approved. Once constructed or installed, all improvements shall be maintained in accordance with the approved plans.
4. All vents, gutters, downspouts, flashings, etc. shall be painted to match the color of the adjacent surfaces. No electrical conduits or similar piping shall be allowed on the exterior of the building unless approved prior to installation by the City of Foster City Community Development Director.
5. Standard residential security requirements as established by Section 15.28.100, Business and Residential Security – Minimum Standards, of Chapter 15.28 of the Foster City Municipal Code shall be provided.
6. Prior to any final building inspection approval, these conditions and all improvements shall be completed to the satisfaction of the City of Foster City.
7. All architectural elements such as soffits, screens, etc., not shown or detailed on the plans shall be finished in a material or color in harmony with the exterior of the building.
8. Once a building permit is issued, it is the permit holder's responsibility to ensure that the project receives a final inspection before the building permit expires (180 days after the last inspection). Failure to receive and/or pass a final inspection will result in the expiration of the building permit, which will require additional fees to reactivate.

REVISED PROTOTYPICAL DESIGN GUIDELINES  
AND NEIGHBOR NOTIFICATIONS

The ACC will no longer require neighbor notifications as part of the Alden Park architectural approval process for front or backyard designs. However, the City of Foster City may require signed neighbor notifications as part of the architectural review process on certain types of projects. Modifications that potentially impact your neighbor's property, such as building additions or changing the size/placement of your windows, are likely candidates for neighbor consent. The exact list of projects and modifications that require this level of documentation is owned and managed by the City of Foster City and can be found through the City Community Development Department. It is the homeowner's responsibility to work with the city to determine if signed neighbor notifications are required as part of the planning and building permit process.

city of foster city  
ADMINISTRATIVE APPROVAL

FEB 10 2011

OP-85-0230  
M



ALDEN PARK CONDITIONS OF APPROVAL FOR FENCES

PLANNING  
DIVISION

1. Replacement fences along public streets including Baffin Street, the entrance of Alden Park at Liberty Lane, Pitcairn Street and Sea Cloud Drive shall conform to the Alden Park Prototypical Design for Fences along Public Streets. Fences along public streets shall be painted to match existing.
2. The design, location, size, height, colors and materials of the replacement fence will be identical to the original fence that was approved with initial construction of the Alden Park planned development. (This includes brick pillars on each side of the entrance and around gates on Sea Cloud Drive)

Alden Park Prototypical Design  
for Privacy Fences

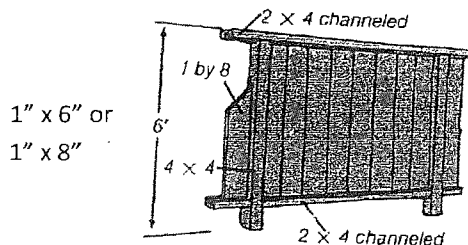

Alden Park Prototypical Design  
for Fences along Public Street

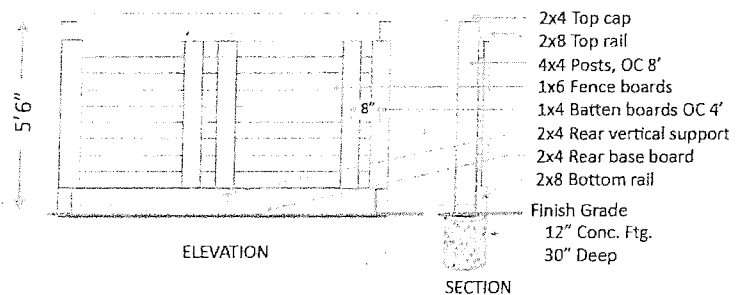

3. All other replacement fences shall conform to the Alden Park Prototypical Design for Privacy Fences illustrated below and shall be located in the same locations as the original fences installed by the developer. Fences located on a common property line, between two adjoining properties within Alden Park, may have fence material above six feet in height, which consists of wood lattice with a weave that is approximately fifty percent open. Total fence height when lattice is used may not extend above seven feet in height above natural grade. Lattice is not allowed on any other fences, including fences facing the street and perimeter fences. All wood is to be redwood. All fences visible to the street shall be left in natural condition or may be treated with a clear sealant.

APPROVAL PROCESS FOR FENCES

1. For fences along public streets, the homeowner or contractor shall apply for an architectural review permit.
2. The Planning/Code Enforcement Division staff will review the architectural review application to confirm that the proposal is consistent with the prototypical design approved for new and replacement fences.
3. For privacy fences that do not adjoin a public right of way, an architectural review permit and building permit are not required.

2010-80-01-3  
CITY OF FOSTER CITY  
PLANNING DEPARTMENT

FEB 10 2011

ADMINISTRATIVE APPROVAL  
PLANNING DIVISION



OCT 29 2010

**ALDEN PARK CONDITIONS OF APPROVAL FOR GARAGE DOORS**

**PLANNING  
DIVISION**

1. A replacement garage door shall be a sectional overhead door with four (4) or five (5) sections. The sections shall have long raised panels: two (2) per section for single car garage doors and four (4) per section for double car garage doors as illustrated in example 1 of the Prototypical Garage Door Designs for Alden Park.
2. The replacement garage door(s) may have rectangular glass inserts in the top row of panels as illustrated in example 2 of the Prototypical Garage Door Designs for Alden Park. Glass inserts may have a trim overlay applied in one of the approved trim patterns identified in example 3 of Prototypical Garage Door Designs for Alden Park. Glass inserts must be colorless and may be clear glass or opaque glass.
3. Garage doors shall be painted pursuant to the Alden Park Exterior Color Paint Rules.
4. If a home has more than one garage door, both/all garage doors must match each other in style, design and color.

**APPROVAL PROCESS FOR GARAGE DOORS**

1. The homeowner or contractor shall apply for a building permit from the Building Inspection Division and shall submit any required drawings and fees.
2. The Planning/Code Enforcement Division staff will review the building permit application to confirm that the proposal is consistent with the prototypical design approved for replacement garage doors.

01-85-0230  
CITY OF FOSTER CITY  
PLANNING DEPARTMENT

FEB 10 2011

ADMINISTRATIVE APPROVAL  
WITH CONDITIONS



OCT 29 2010

PLANNING  
DIVISION

Alden Park Prototypical Design for Garage Doors

Example 1:

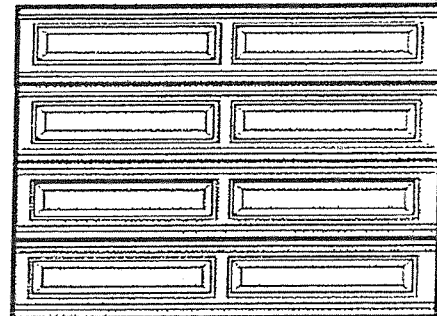
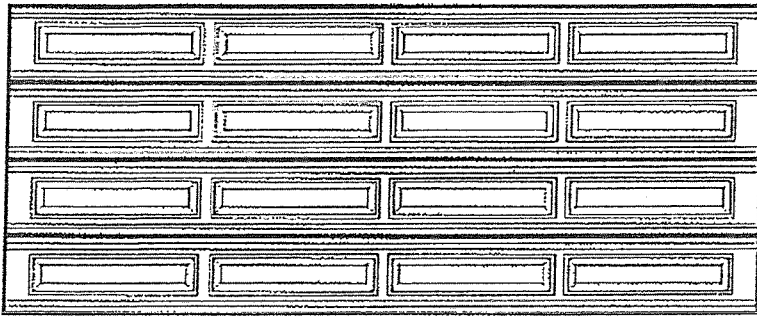

Example 2:

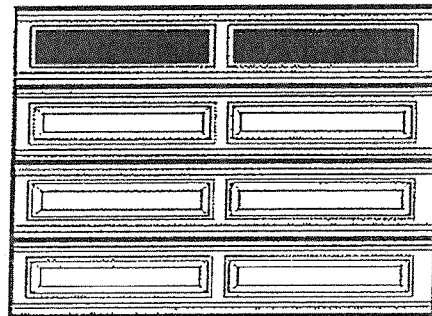
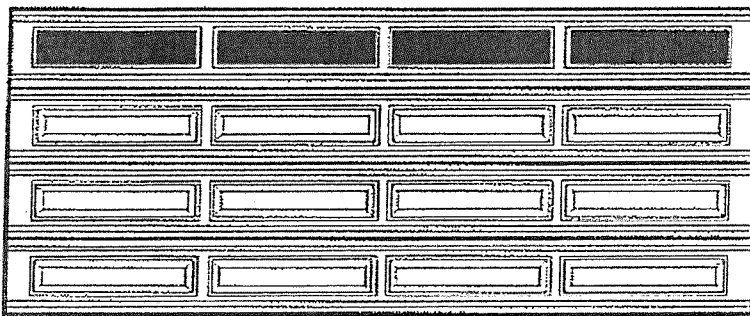

Example 3:

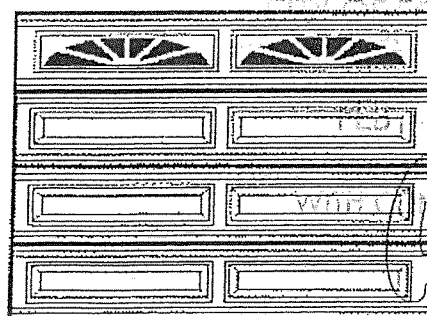
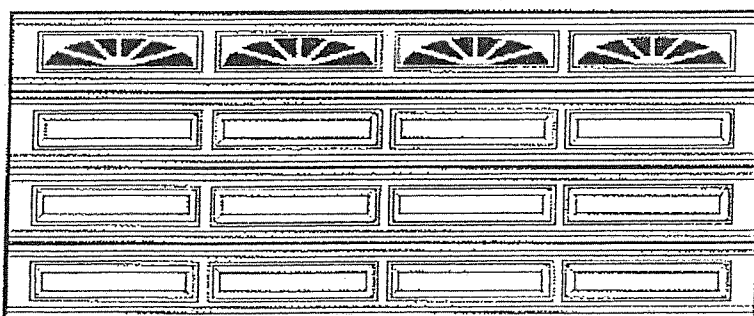
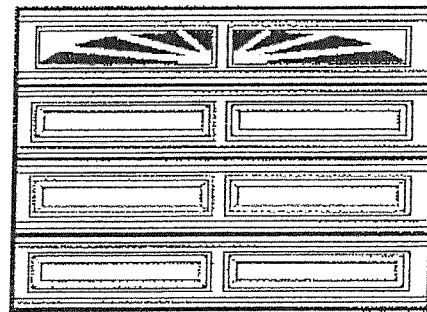
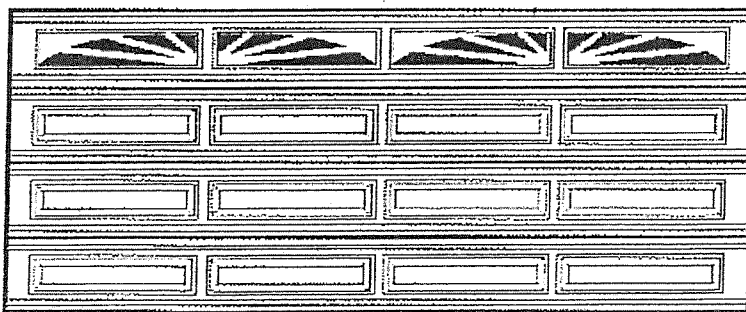
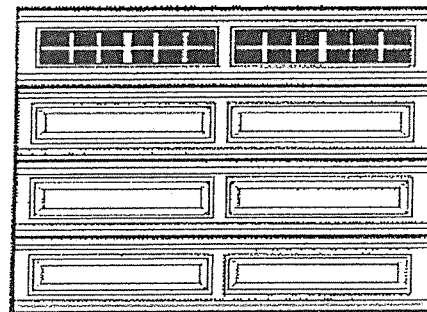
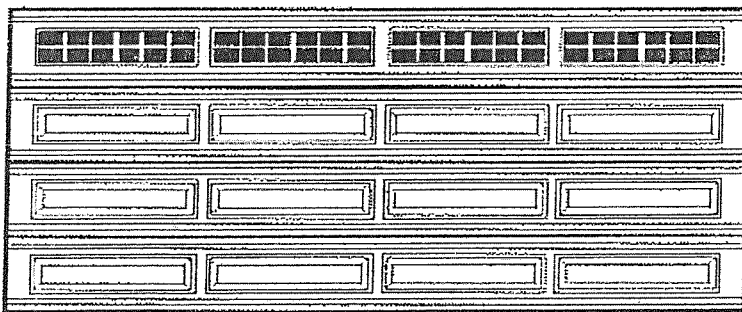

0155-0730

FOSTER CITY  
PLANNING  
DIVISION

2010

APPROVED  
[Signature]



### ALDEN PARK CONDITIONS FOR APPROVAL OF HOUSE COLORS

1. All materials and colors shall be approved. Once painted, all improvements shall be maintained in accordance with the approved colors.
2. For any repainting of the exterior of the house with the same color or any color change, the homeowner or contractor shall use one of the Alden Park approved color schemes in accordance with the Exterior Color Paint Rules – 2009 Update. The Exterior Color Paint Rules and the approved color schemes are contained in the binder on file with the City of Foster City Community Development Department, identified as “Alden Park Foster City, CA Exterior Home Colors – 2009 Update.” A duplicate binder is on file with the Alden Park Architectural Control Committee.

### APPROVAL PROCESS FOR HOUSE COLORS

1. The homeowner/applicant shall obtain a letter indicating the action of the Alden Park Homeowners' Association for any house color change.
2. No permit or prior approval from the City of Foster City of a particular scheme from the approved color scheme is required.

01-85-0230  
CITY OF FOSTER CITY  
COMMUNITY DEVELOPMENT DEPARTMENT  
FEB 11 2011  
COMMUNITY DEVELOPMENT DEPARTMENT  
APPROVED  
[Signature]



## EXTERIOR COLOR PAINT RULES – 2009 UPDATE

1. All repainting, other than reuse of the same color scheme on the house pursuant to the approved color schemes, must have prior approval of the Architectural Control Committee.
2. All houses must be painted in one of the approved color schemes. All colors can either be ordered from the designated manufacturer or matched exactly by another paint company. A genuine effort must be made to match the approved color schemes.
3. Any house may be painted in any one of the approved color schemes. However, no two houses side by side or directly across from each other may be painted in the same siding color.  

NOTE: New color schemes 2003 – 4A, 4B and 4C are considered the “same” color for this rule. Therefore, a house siding painted one of the schemes 4A, 4B or 4C can not be adjacent to or directly across from a house with siding color 4A, 4B or 4C.
4. It is recommended that the accent color from the 2003 Color Schemes be used as the color for both shutters and doors. While the use of one accent color is preferred, a second accent color, selected from the approved Color Schemes, may be selected for the front door.
5. Garage Doors should be repainted in one of the following manners:
  - Garage door and trim around the garage door may be painted the siding color. This is consistent with some existing houses but not preferred.
  - For all Color Schemes other than FL and 2003-5 (“white” houses) in which the trim color is lighter than the siding color, the garage door and trim around the garage door should be painted the trim color. For all Color Schemes FL and 2003-5 (“white” houses) only, the garage door and trim around the garage door should be painted the trim color.
6. Eaves may be painted in either white or trim color if the trim color is lighter than the siding color.
7. All paint is to be flat or very low sheen flat, latex base paint. No paint should have a glossy look, except a front door.
8. When matching Original (1986) and/or Updated (1992, 2003, 2009) colors, use the manufacturer color number, rather than matching existing paints on houses as they have likely faded.
9. Approvals for color changes will be on a “first come” basis. An approved color scheme may not be “banked” for the future. Approval is valid for sixty days. If painting has not commenced within sixty days, the color scheme becomes available for other houses.
10. Color patches are available within the Alden Park Exterior Color Binder for review. Contact a member of the Alden Park Architectural Control Committee.

AP-81-0236  
ALDEN PARK CITY  
PLANNING DEPARTMENT  
FEB 19 2011  
ADJ. APPROVAL





OCT 29 2010

PLANNING  
DIVISION

### ALDEN PARK CONDITIONS OF APPROVAL FOR ROOFS

1. The approved roofing material for the Alden Park Planned Development is:  
**Certainteed Landmark Premium Shingles in the Platinum or Successor color.**
2. The roof over a bay window shall match the main roof. Copper may be used as an alternate material for the roof over a bay window (1) in rear yards only and (2) when not visible from a public or private right-of-way.

### APPROVAL PROCESS FOR ROOFS

1. The homeowner or contractor shall apply for a building permit from the Building Inspection Division and shall submit any required drawings and fees.
2. The Planning/Code Enforcement Division staff will review the building permit application to confirm that the proposal is consistent with the prototypical design approved for replacement roofs.

### ALDEN PARK CONDITIONS OF APPROVAL FOR SKYLIGHTS

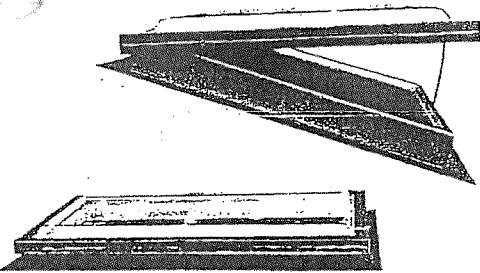

1. **Frame:** Aluminum extrusion baked enamel finish. Color to match roof of the house. May not protrude more than 10" from the surface of the roof.
2. **Glazing:** Clear or tinted tempered glass or acrylic, the surface of which must be flat and parallel to the surface of the roof (no "bubbles.")

PROTOTYPICAL SKYLIGHT

### APPROVAL PROCESS FOR SKYLIGHTS

1. The homeowner/applicant shall obtain a letter indicating the action of the Alden Park Homeowners' Association for the proposed skylight change.
2. The homeowner or contractor shall apply for a building permit from the Building Inspection Division and shall submit any required drawings and fees.
3. The Planning/Code Enforcement Division staff will review the building permit application to confirm that the proposal is consistent with the prototypical design approved for new and replacement skylights.

170-53-0720  
PLANNING DEPARTMENT

FEB 10 2011

ADMINISTRATIVE ASSISTANT  
WILSON COUNTY  
8



### ALDEN PARK CONDITIONS OF APPROVAL FOR WINDOWS

1. Replacement windows shall have a white frame. Narrow white frames and sash widths should be selected to closely match the existing windows and shall not exceed 3" total width, including the frame and external fin, if any.
2. Replacement windows shall have colorless glass. The use of LowE Glass is allowed.
3. Replacement windows shall have a wood trim consistent in design and color with the existing trim on all windows, per the approved building color scheme on file with the city.
4. Windows may have grids, no grids, or partial grids. If grids are to be used, one type of approved grid pattern may be used on the same elevation. See exhibit "A" attached hereto and made a part hereof for approved window grid patterns.
5. Sidelights and windows above the front door may have colorless, decorative glass. Decorative glass is described as the use of textured glass, such as etched, seedy, ripple, glue chip, reed or waterglass, etc., in a decorative pattern with came, with or without bevels.
6. All windows on each elevation shall match in terms of frame color and materials, window type and style (ie slider, hung, etc...) and the use of grids.
7. On the rear elevation only on a single story house or the 1<sup>st</sup> floor of a 2-story house, the windows on the 1<sup>st</sup> story may be a mix of windows with and without grids but the frame color and materials and window type and style shall match.
8. The decision whether to replace a sliding glass door or a French door or a garden window shall be at the option of the property owner. If a sliding glass door or a French door is replaced, its design type and style, colors and materials and use of grids shall match the windows/sliding glass doors on each elevation.

01-55-0230

### APPROVAL PROCESS FOR WINDOWS

1. The homeowner or contractor shall apply for a building permit from the Building Inspection Division and shall submit any required drawings and fees.
2. The Planning/Code Enforcement Division staff will review the building permit application to confirm that the proposal is consistent with the prototypical design approved for new and replacement windows.

01-55-0230

### Exhibit A

#### Approved Window Grid Patterns

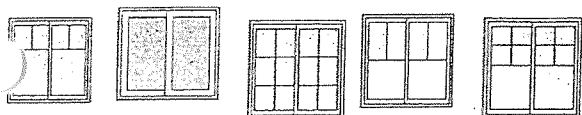

#### Window Grid Patterns that are NOT Approved

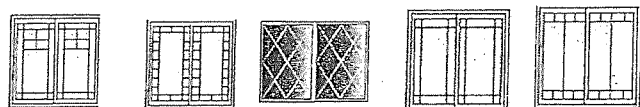



**ALDEN PARK CONDITIONS OF APPROVAL FOR YARD FEATURES**

PLANNING  
DIVISION

*The intent of these design guidelines is to preserve the architectural character of the neighborhood and the quiet enjoyment of each homeowner of their property. Structures, pools, spas, lighting and other landscape features have the potential to impact the character of the neighborhood and may impact the enjoyment of neighborhood properties. Consideration will be given to the impact on the neighborhood and to the adjacent properties in the review of proposed improvements.*

**GARDEN STRUCTURES:** Garden structures are defined to include all vertical elements and raised decks of any kind in side and rear yards that are 18" above natural grade or taller. Structures include greenhouses, above-ground spas and pools, trellises, arbors, built-in barbeques, fountains, walls, fire pits, privacy screens, gazebos and any other item. These structures shall not be attached to the house.

1. **Height:** Height shall be measured from natural grade. No structure shall exceed 9' 6" in height. Greenhouses shall not exceed 9' 6" in height. Garden structures in side yards that will be visible above the fence may not exceed 9' 6".
2. **Materials for Arbors, Trellises and Screens:** Materials shall be redwood or cedar painted or stained to match the lighter color on the house and trim or with a clear sealer. Raised decks shall comply with materials for decks less than 18" tall. Plexiglas and other transparent substitutes are not allowed.  
  
Structures with roofs are discouraged and shall require Alden Park Architectural Control Committee approval. Roof material shall exactly match roof material of dwelling unit. Storage sheds may not exceed the fence line height and in no case may exceed 6' in height.
3. **Trellises:** A trellis is not to be attached to the house in any way. Supporting posts may not be closer than 5' from the side property line. The canopy line where closer than 5' to the side property line may not exceed 9' 6" in height and may not intrude more than 18" into the side yard setback. Trellis construction is to be of redwood or cedar and surfaced on all sides, construction heart or better. The paint or stain shall match the house and trim or clear sealer.
4. **Greenhouses:** The frame shall be aluminum extrusion baked enamel finish with the color to match the trim of the house. The glazing shall be tempered glass.
5. **Gazebos:** The height of a gazebo (dimension "B" of Prototypical Gazebo) is taken from the ground level to the top of the gazebo and shall not extend higher than 9'6". The height of the platform must be included in the 9' 6" height if located on a platform (deck). Above grade gazebos shall be wood with sealed natural finish or painted white. 01-85-0230

All gazebos require Alden Park Architectural Control Committee approval and City of Foster City Planning/Code Enforcement Division approval due to varying lot sizes and the size of the gazebo.

CITY OF FOSTER CITY  
FEB 10 2011

ADMINISTRATIVE APPROVAL  
W/PLANNING DIVISION  
10



PLANNING  
DIVISION

6. **Locations and Setbacks:** Setbacks are allowable in rear yards only with an area defined in the Locations and Setbacks Diagram attached hereto. All site features of any kind shall conform to these setbacks including, but not limited to, garden structures of 18" and taller, as described above, and decks, patios, walks and other features.
- A) All garden structures, including greenhouses, trellises, patio covers and other above grade structures, shall be located within this area, no closer than 5' to the side property line and 5' to the rear property line when the distance from the unit to the rear property line is 20' or greater. In addition, they may not extend toward the rear property line more than half the distance from the unit to the rear property line. If the distance from the unit to the rear property line is 19' or less, then the trellis, patio cover and other above grade structures shall extend no closer than 9' toward the rear property line.
  - B) Structures at the ground level, at natural grade, such as decks, patios and other flatwork, shall be no closer than 18" to the property line. However, 50% of the side yard may be paved for utility purposes.
  - C) All garden structures in side yards that will be visible above the fence require site-specific approval.
  - D) Trellis joints, stringers and beams, as indicated in the Prototypical Trellis sketch attached hereto and made a part hereof, **in rear yards** may encroach in the setbacks 18" maximum but shall not exceed 9' 6" above natural grade. Posts, walls and other vertical elements shall not encroach in required setbacks.
  - E) Structures in front yards are not allowed except for vine supports at the first floor within 1' of the exterior wall of the house.
  - F) The City of Foster City Municipal Code has additional setback requirements for spas and pools.

Locations and Setbacks

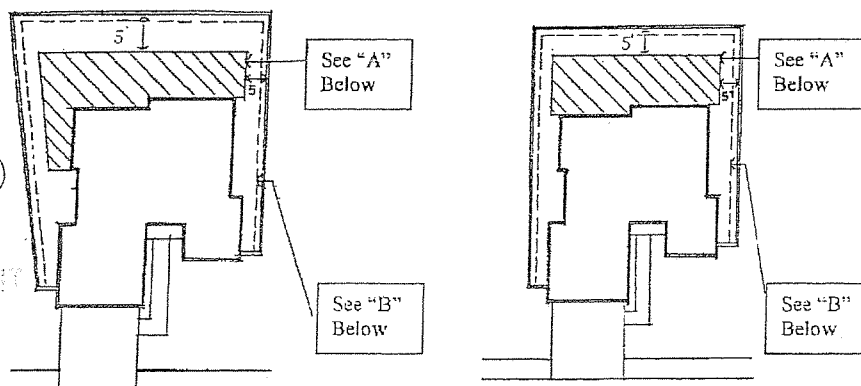

00-85-0130

CITY OF FOSTER CITY  
PLANNING DEPARTMENT

FEB 10 2011

ADMINISTRATIVE APPROVAL  
WITH CONDITIONS



**DECKS, PATIOS, TERRACES AND OTHER FLATWORK INCLUDING CONCRETE, MASONRY AND OTHER MATERIALS:** Structures at ground level, at natural grade, or less than 18" above natural grade shall conform to setback requirements in Diagram "a" above.

1. **Materials:** Materials used for decks, patios, paving and other flatwork shall be durable materials in natural colors consistent with the Alden Park color palette. Site-specific approval is required for use of a deep, bright or non-natural colors or any material that may not be durable. Redwood or cedar with a clear sealer is the only wood allowed for decks. Concrete, brick and natural stone are considered more durable than wood in close proximity to grade. Composite decking material may also be used for the deck surface.
2. **Locations:** These structures are allowed only in side and rear yards within the area defined for Garden Structures under Locations and Setbacks, sections A and B, including the Location and Setbacks Diagram "a" and "b."

Raised decking 18" or taller requires Alden Park Architectural Control Committee approval. In no case shall decking height exceed 24" above natural grade adjacent.

**LIGHTING:** Exterior lighting shall be mounted within the setbacks in an aesthetically pleasing manner at a maximum height of 8' above natural grade. All lighting shall be directed/shielded down toward the ground with the exception of low voltage up lighting, which is only allowed within 18" of natural grade. It is the intent of this guideline to reduce light pollution and glare to neighbors and the night sky.

**POOLS AND SPAS:** The construction of any in ground structure is subject to ground water effects, and engineering services are required to assure proper relief.

1. **Materials:** Materials allowed include cast-in-place concrete, pre-cast concrete or pneumatically placed concrete (Gunite). These must be backfilled, plastered or tiled. Integral color plaster is encouraged. Preformed fiberglass is also allowed. A tile covering is encouraged.
2. **Locations:** Locations are allowable in rear yards only and shall conform to Section 17.66 of the Foster City Zoning Ordinance.

Pool and/or spa equipment, which are separate from the pool and/or spa, shall be no closer than 20' to any dwelling unit except property Owners' and must be sound insulated to the satisfaction of the City of Foster City.

The total area of any above ground pool and/or spa may not exceed 100 square feet in surface area and may extend no more than 4' above grade. Any pools and/or spas above grade are subject to the same location criteria as those located below ground.

CITY OF FOSTER CITY  
PLANNING DEPARTMENT  
0185-0230  
FEB 10 2011  
ADMINISTRATIVE APPROVAL



OCT 29 2010

PLANNING  
 DIVISION

Prototypical Trellis  
 Garden Structures (3)

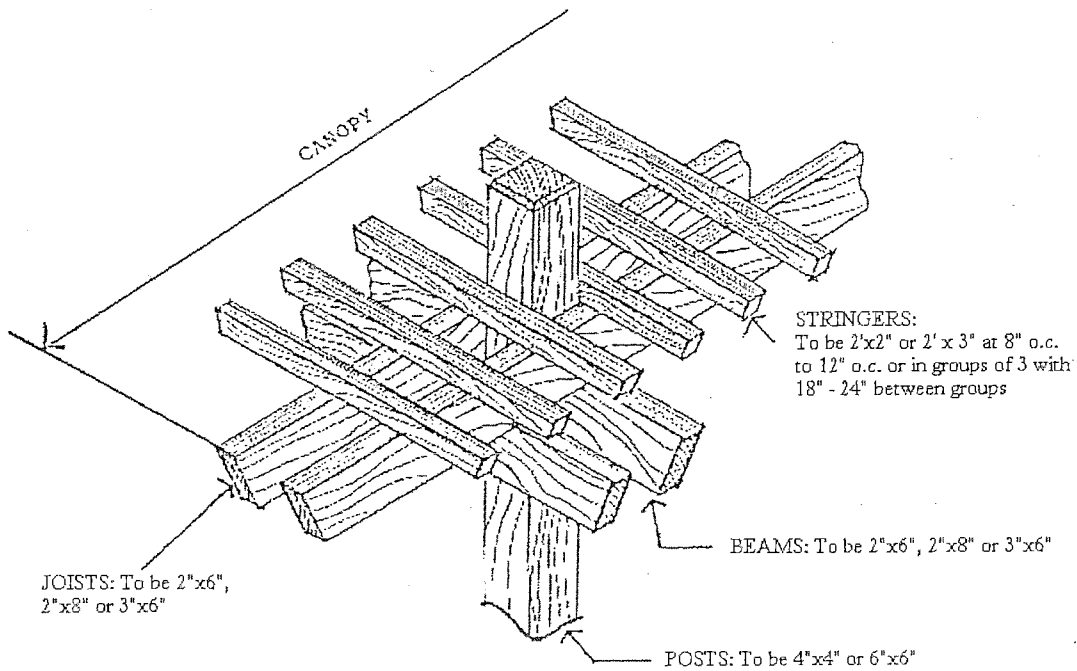

BEAM AND JOINT TREATMENTS

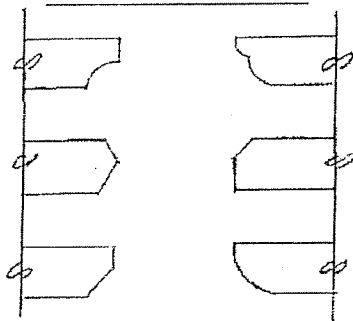

STRINGER TREATMENTS

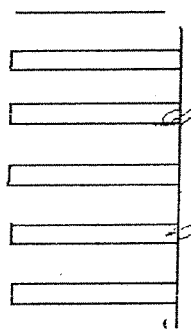

60-85-0230  
 CITY OF FOSTER CITY  
 PLANNING DEPARTMENT

FEB 10 2011

ADMINISTRATIVE APPROVAL  
 WITH COMMENTS

Prototypical Wood Deck

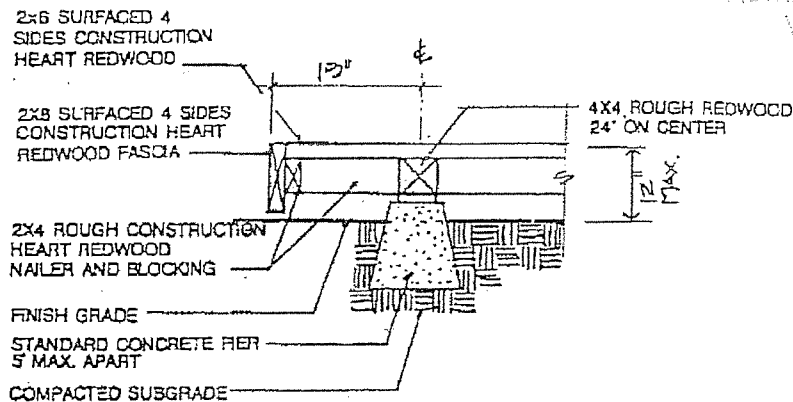



FOSTER CITY  
 RECEIVED  
 OCT 29 2010  
 PLANNING  
 DIVISION

Prototypical Unattached Greenhouse  
 Garden Structures (4)

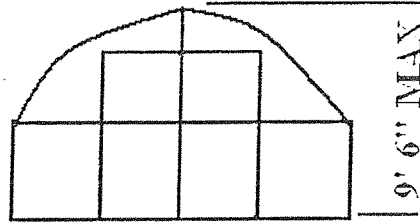
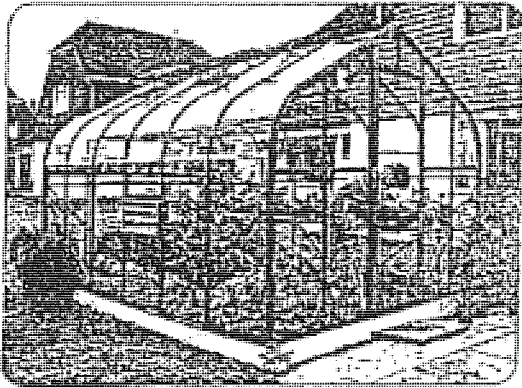

Prototypical Gazebos  
 Garden Structures (5)

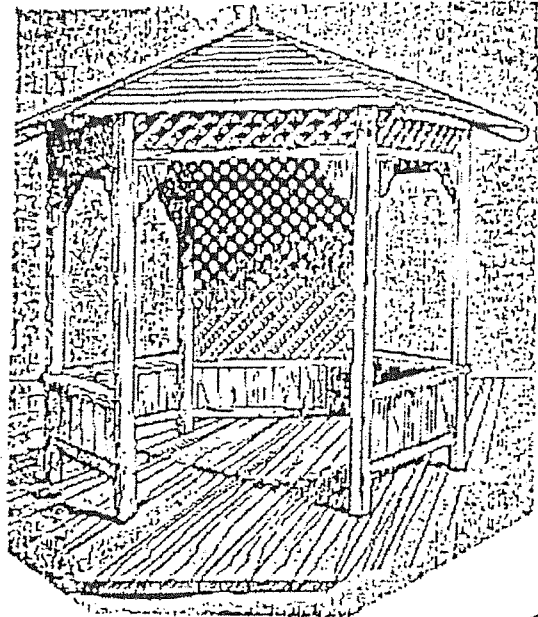
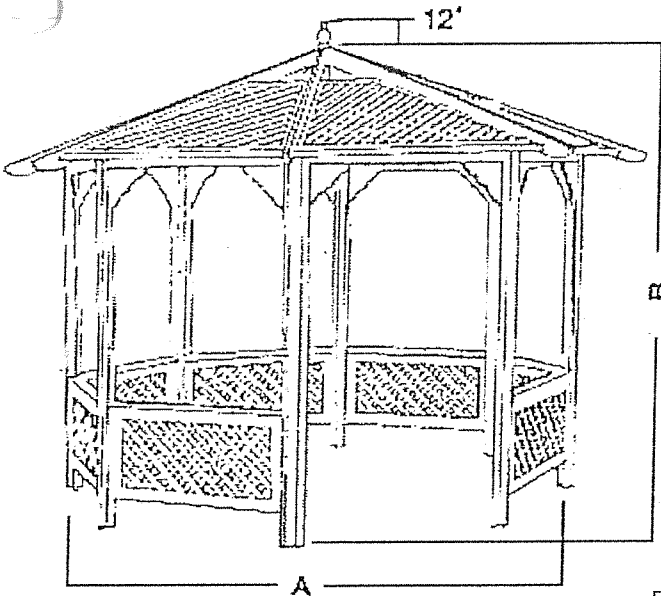

(A)	(B)
8.0'	9' 6" MAX
11.0'	
13.0'	

09-85-0230  
 CITY OF FOSTER CITY  
 PLANNING DEPARTMENT  
 FEB 10 2011  
 ADMINISTRATIVE APPROVAL  
 [Signature]  
 14



OCT 29 2010

**APPROVAL PROCESS FOR YARD FEATURES:**

PLANNING  
DIVISION

1. The homeowner or contractor shall apply for an Architectural Review Permit from the Planning/Code Enforcement Division of the City of Foster City and shall submit any required drawings and fees, including the letter from the Alden Park Homeowners' Association Architectural Control Committee for all structures taller than the fence line plus decks that are not exempt.
2. The homeowner or contractor shall apply for a building permit from the Building Inspection Division and shall submit any required drawings and fees.
3. The Planning/Code Enforcement Division staff will review the building permit application to confirm that the proposal is consistent with the prototypical design approved for yard features or garden structures.

UP-85-0230

CITY OF FOSTER CITY  
PLANNING DEPARTMENT

FEB 10 2011

ADMINISTRATIVE APPROVAL  
WILL CONTAIN



ALDEN PARK HOMEOWNERS' ASSOCIATION  
Prototypical Design Guidelines



Alden Park Developer's Site Map with Addresses & Lot Numbers

FOSTER CITY  
RECEIVED  
OCT 29 2010  
PLANNING  
DIVISION

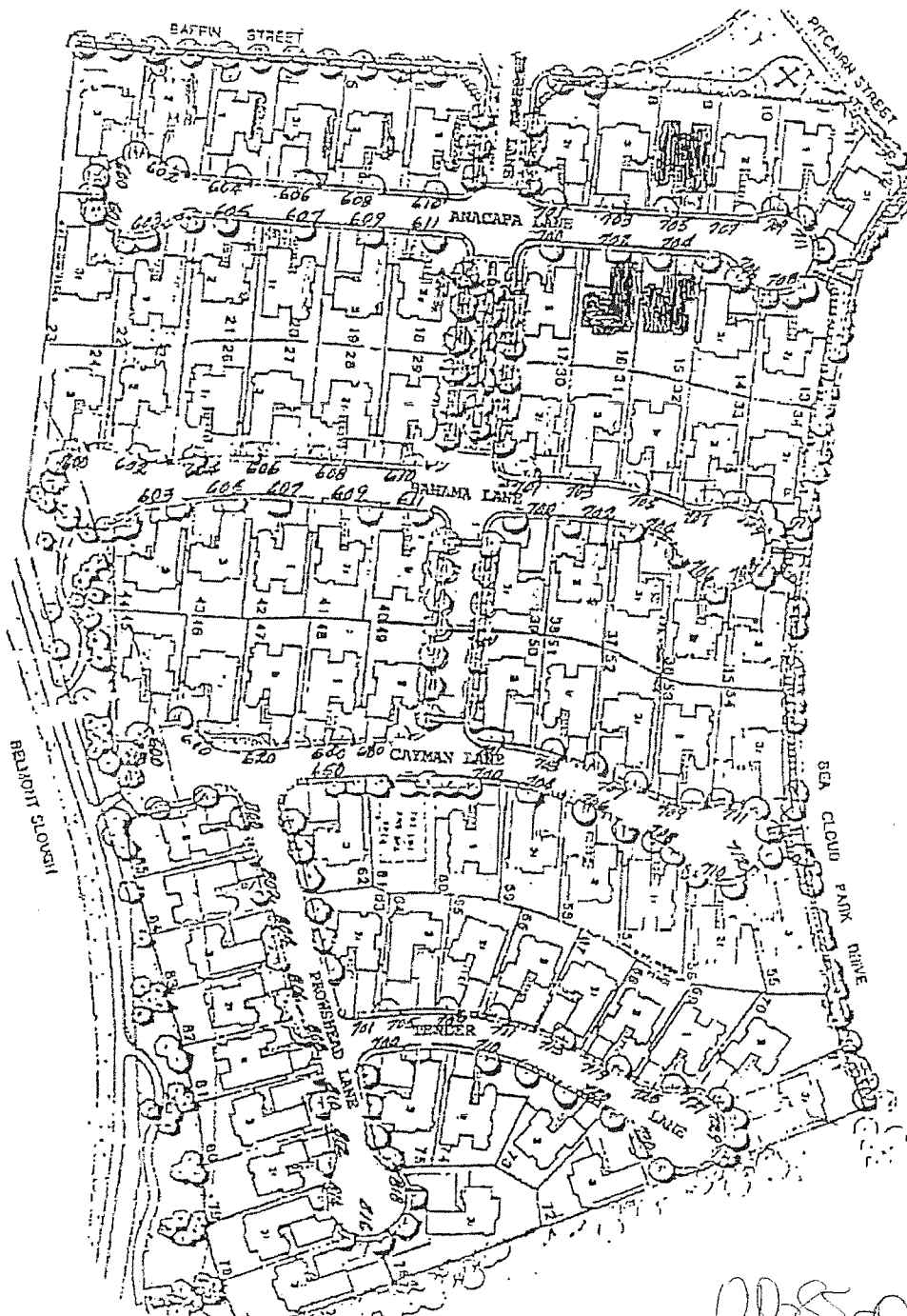

0P-85-0230  
FOSTER CITY  
PLANNING DEPARTMENT  
FEB 10 2011  
ADMINISTRATIVE APPROVAL  
W/ COMMENTS  
*[Signature]*

ALDEN PARK HOMEOWNERS' ASSOCIATION  
 Prototypical Design Guidelines



Alden Park County Assessor's Map

FOSTER CITY  
 RECEIVED

OCT 29 2010

PLANNING  
 DIVISION

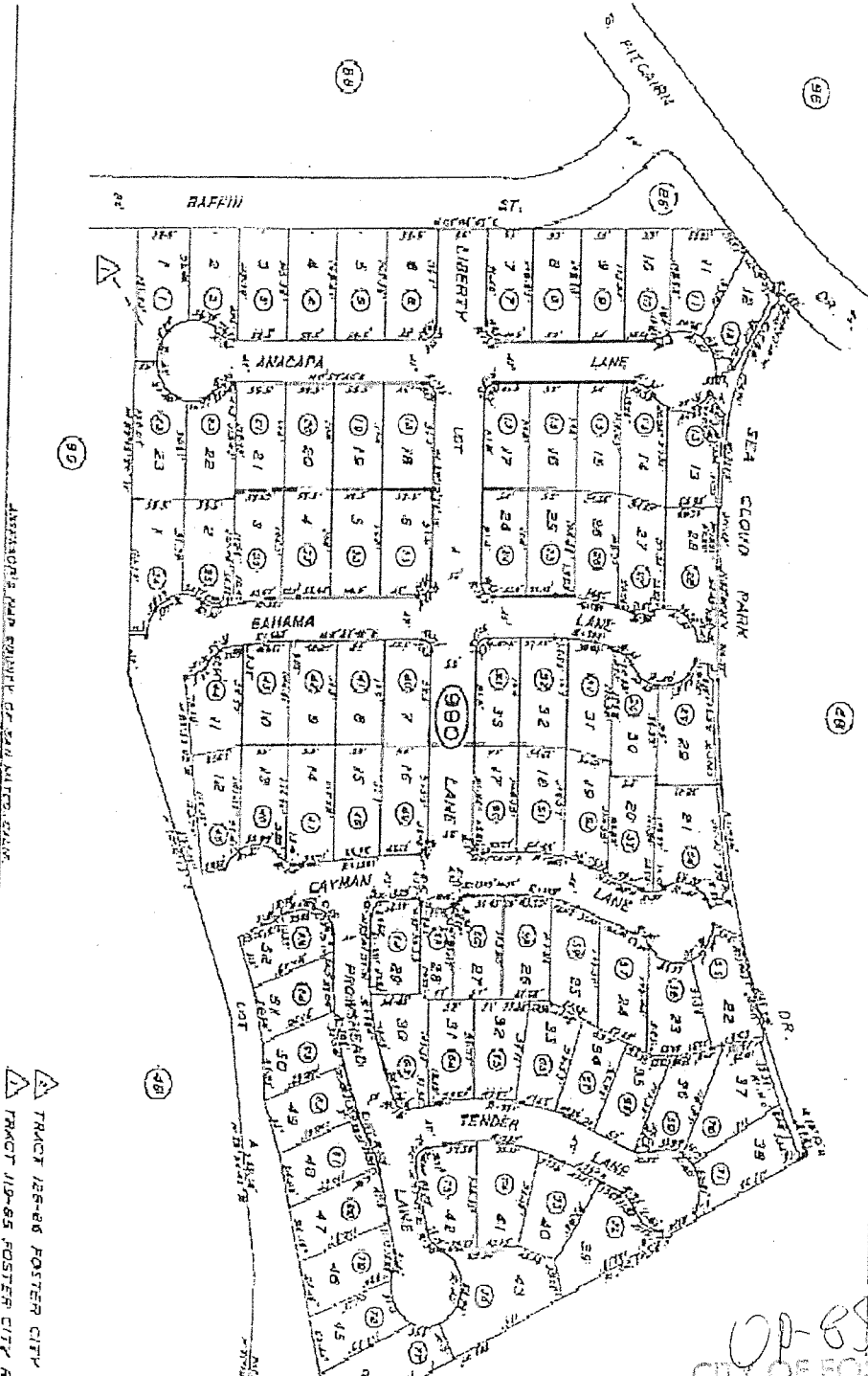

▲ TRACT 125-86 FOSTER CITY  
 ▲ TRACT 119-65 FOSTER CITY R

01-85-0720  
 CITY OF FOSTER CITY  
 PLANNING DEPARTMENT  
 FEB 10 2011  
 ADMINISTRATIVE APPROVAL  
 CITY COMMISSIONS



OCT 29 2010

**DECKS, PATIOS, TERRACES AND OTHER FLATWORK INCLUDING CONCRETE, MASONRY AND OTHER MATERIALS:** Structures at ground level, at natural grade, or less than 18" above natural grade shall conform to setback requirements in Diagram "a" above.

1. **Materials:** Materials used for decks, patios, paving and other flatwork shall be durable materials in natural colors consistent with the Alden Park color palette. Site-specific approval is required for use of a deep, bright or non-natural colors or any material that may not be durable. Redwood or cedar with a clear sealer is the only wood allowed for decks. Concrete, brick and natural stone are considered more durable than wood in close proximity to grade. Composite decking material may also be used for the deck surface.
2. **Locations:** These structures are allowed only in side and rear yards within the area defined for Garden Structures under Locations and Setbacks, sections A and B, including the Location and Setbacks Diagram "a" and "b."

Raised decking 18" or taller requires Alden Park Architectural Control Committee approval. In no case shall decking height exceed 24" above natural grade adjacent.

**LIGHTING:** Exterior lighting shall be mounted within the setbacks in an aesthetically pleasing manner at a maximum height of 8' above natural grade. All lighting shall be directed/shielded down toward the ground with the exception of low voltage up lighting, which is only allowed within 18" of natural grade. It is the intent of this guideline to reduce light pollution and glare to neighbors and the night sky.

**POOLS AND SPAS:** The construction of any in ground structure is subject to ground water effects, and engineering services are required to assure proper relief.

1. **Materials:** Materials allowed include cast-in-place concrete, pre-cast concrete or pneumatically placed concrete (Gunitite). These must be backfilled, plastered or tiled. Integral color plaster is encouraged. Preformed fiberglass is also allowed. A tile covering is encouraged.
2. **Locations:** Locations are allowable in rear yards only and shall conform to Section 17.66 of the Foster City Zoning Ordinance.

Pool and/or spa equipment, which are separate from the pool and/or spa, shall be no closer than 20' to any dwelling unit except property Owners' and must be sound insulated to the satisfaction of the City of Foster City.

The total area of any above ground pool and/or spa may not exceed 100 square feet in surface area and may extend no more than 4' above grade. Any pools and/or spas above grade are subject to the same location criteria as those located below ground.

CITY OF FOSTER CITY  
PLANNING DEPARTMENT  
DP-85-0230  
FEB 10 2011  
ADMINISTRATIVE APPROVAL



OCT 29 2010

PLANNING  
 DIVISION

Prototypical Trellis  
 Garden Structures (3)

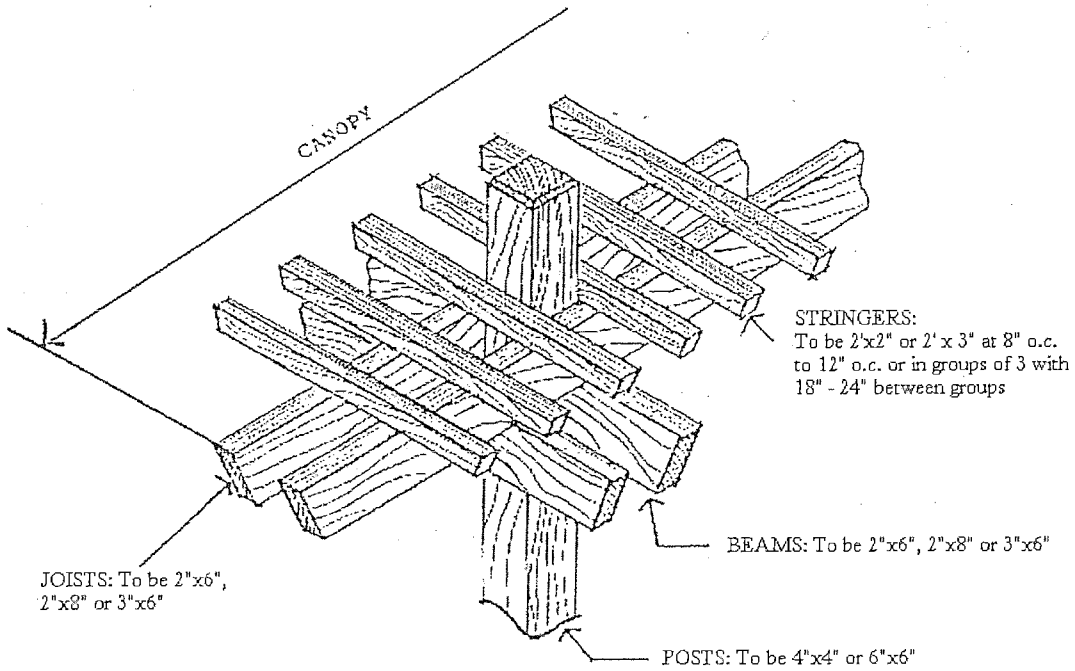

BEAM AND JOINT TREATMENTS

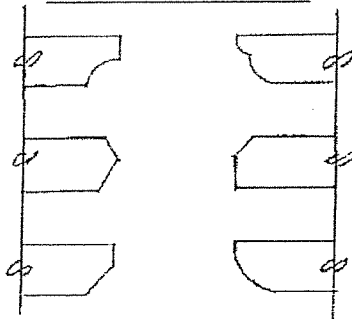

STRINGER TREATMENTS

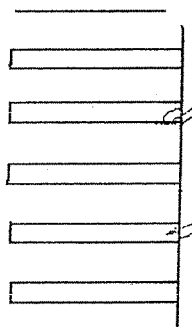

20-85-0230  
 CITY OF FOSTER CITY  
 PLANNING DEPARTMENT

FEB 10 2011

ADMINISTRATIVE APPROVAL  
 WITH COMMENTS

Prototypical Wood Deck

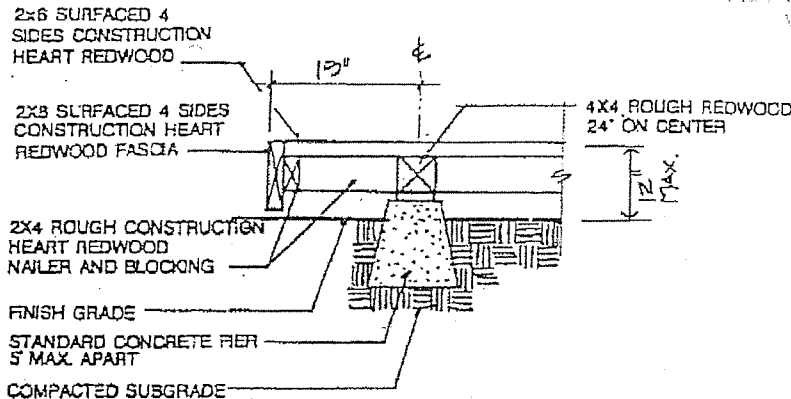



OCT 29 2010

**APPROVAL PROCESS FOR YARD FEATURES:**

PLANNING  
DIVISION

1. The homeowner or contractor shall apply for an Architectural Review Permit from the Planning/Code Enforcement Division of the City of Foster City and shall submit any required drawings and fees, including the letter from the Alden Park Homeowners' Association Architectural Control Committee for all structures taller than the fence line plus decks that are not exempt.
2. The homeowner or contractor shall apply for a building permit from the Building Inspection Division and shall submit any required drawings and fees.
3. The Planning/Code Enforcement Division staff will review the building permit application to confirm that the proposal is consistent with the prototypical design approved for yard features or garden structures.

UP-85-0230

CITY OF FOSTER CITY  
PLANNING DIVISION

FEB 10 2011

ADMINISTRATIVE / ENGINEER  
WILL CONSIDER